

# Data Sheet



Article number: 03704008

Description: Fluro rod end BRM 8  
with ball bearing

## Measures

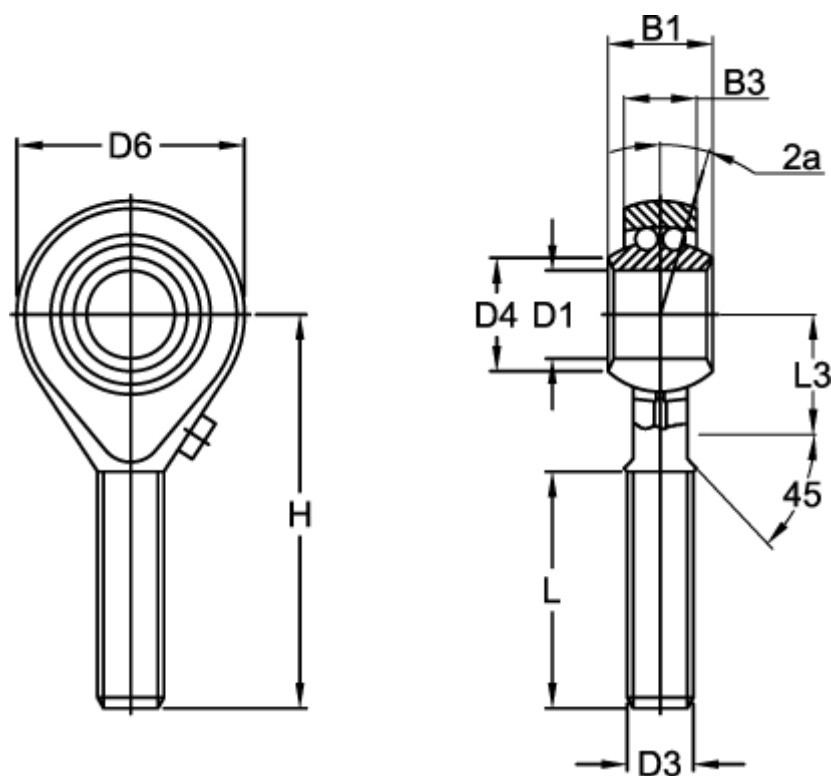

Angel 2a	= 8.5	H	= 42
B1	= 12	L	= 25
B3	= 9.00	L3	= 15
D1	= 8	Max rpm	= 1300
D3	= M8x1,25	Static load (N)	= 1000
D4	= 10.5	Weight (kg)	= 0.036
D6	= 24		
Dynamic load C (N)	= 4000.0		